

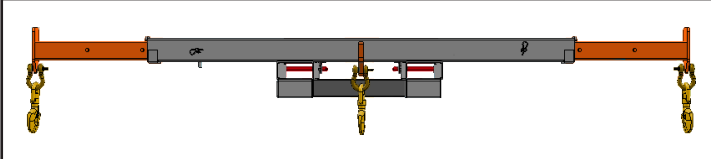

FORKLIFT

SPREADER BAR

Operator's Manual
 for Model 1150C-FP300C



RATED LOAD CAPACITY	
Empty Weight - 545lbs.	
Center Hook used alone	6,000 lbs.
At 8 feet wide	8,000 lbs.
Extended to 10 feet wide	6,400 lbs.
Extended to 12 feet wide	5,000 lbs.

BEFORE USE, READ AND UNDERSTAND THE COMPLETE OPERATOR'S MANUAL.

If you need clarification or any additional information call your Star dealer or call Star Industries @ 1-800-541-1797 during normal business hours.

INSTALLATION, USE & SAFETY PRECAUTIONS

The model 1150C-FP300C Extendable Spreader Bar is designed for use with a rough terrain forklift of adequate capacity to safely handle the load. The Spreader Bar extends from 8 feet to 10 feet to 12 feet and comes equipped with fork pockets that will accept up to 7" wide X 3" thick forks. Fork pockets are 30" apart Off Center and requires a 38" or wider carriage. Be aware that the information contained in this manual is intended as a guide and does not replace the need for the user to know, understand, and observe all applicable company, local, state, and federal safety codes and or requirements. The model 1150C-FP300C meets/exceeds the requirements of ASME B30.20-2006 and is classified as Category A and Service Class 0 as defined in ASME BTH-1-2005.

DANGER - DO NOT USE WITHOUT INSTALLING RETAINING PINS behind the heel of each fork and securing with hair pins or cotter pins

Safety chain(s) must also be used. Wrap chain around a strong part of the fork carriage and secure with locking grab hook.

BEFORE USE, READ AND UNDERSTAND THE COMPLETE OPERATOR'S MANUAL.

If you need clarification or any additional information call your Star dealer or call Star Industries @ 1-800-541-1797 during normal business hours.

Customers Who Bought this product also bought



Lift Hooks -
Lift up to 22,000 lbs
Safely and securely

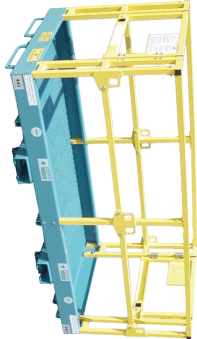

Safety Work Platforms -
Turn your forklift into an
Aerial work platform



Concrete Hoppers -
Turns Your forklift into
A concrete placer.

Visit www.starindustries.com or call us at 800-541-1797 for more information on these and other great products.

Before Use:

1. Make sure the operator is well qualified to operate the specific forklift model to be used, has read and understands this manual and has reviewed the forklift operator's manual for any additional requirements, limitations, restrictions, or additional safety procedures prescribed by the forklift/crane manufacturer when using this type of attachment. The forklift operator must also be properly certified under OSHA requirements to operate the forklift to be used.
2. Inspect the spreader bar to make sure it is in good condition. There must not be any broken welds, nor any deformation of the steel tube or other component, nor any cracks in the steel.
3. Inspect swivel hooks and shackles to make sure they are complete, are in good condition, and shackle anchor screw pins or bolts are tight.
4. Check to make sure the fork retaining pins have hair pins to secure them in place and safety chains are properly secured to anchor blocks and grab hooks are properly secured.
5. Grab Hook on safety chain must be locking type. If a replacement is required, contact your Star dealer or Star Industries directly.
6. Decals showing "Empty Weight", "Read Before Using" and "Rated Lift Capacity" are required. Check that all decals are in place and legible. Replacement decals are available from a Star dealer.
7. Make sure personnel involved understand any hand signals that will be required and all involved personnel understand what will be required of them.
8. Make sure the travel path is clear of obstructions and that adequate clearance will be maintained from all power lines.

Caution:

1. Risks are high for serious injury when working around suspended loads. The operator must avoid carrying the load over people and it is best to have a 10' foot rule. This requires that no one is allowed to be within 10 feet of the area in which the load would fall if a failure occurred.
2. Do not allow anyone to ride on the spreader bar nor on the load being carried.
3. Do not make any repairs or modifications to the spreader bar without written authorization from the manufacturer. Replacement of hooks, shackles, decals and hair-pins does not require authorization.

WARRANTY PROCEDURE:

Upon notification, Star Industries will advise if the product will need to be returned to Star Industries for inspection and/or repair, or If the Star Dealer, or other entity, can be authorized to make the inspection/repair at their location, or if circumstances dictate other solutions. Dealer or other entity repairs must have prior written authorization. A "cost of repair" estimate will be required prior to authorization. Reimbursement will be at the current "Star Warranty Labor Rate" and will not include reimbursement for off-site travel. A Warranty Claim Form must be submitted within 45 days of warranty repair authorization to receive credit for repair. A return authorization number must be obtained from Star Industries before a product can be returned for inspection and/or warranty and that number must appear on the return shipping label. Upon inspection, Star Industries will determine if the product is defective and if so, whether it will be repaired or replaced. Repair or replacement is at the discretion of Star Industries. Transportation charges to Star Industries are not covered under the warranty and must be prepaid by dealer or customer unless it is within the first two years of warranty. In which case, if evidence acceptable to Star Industries, is provided that the product is defective and the return is from within the continental United States or Canada, Star will arrange for return shipment at Star Industries expense. Products found to be defective within the initial two year period and returned to Star Industries for repair or replacement will be returned to the dealer or customer freight prepaid providing it is within the continental United States or Canada. Warranted products to be shipped outside the United States or Canada and those warranted after the initial 2 years will be shipped freight collect. Unwarrantable products will be returned freight collect at the request of the dealer or customer, otherwise they will be destroyed.

LIMITATION OF DAMAGES:

Star's obligation under this warranty shall not include costs of installation, duty, taxes or any other charges whatsoever or any liability for direct, indirect, incidental or consequential damages or delay. Star's liability for any and all losses and damage to purchaser resulting from any cause whatsoever, including negligence or breach of form of warranty, express or implied by Star, alleged damage for defective goods, irrespective of whether such defects are discoverable or latent, shall in no event exceed the purchase price of the particular goods. Products repaired or replaced under this warranty are warranted only for the remainder of the original warranty. Any improper use including operation after discovery of defective or worn parts not approved by Star or any alteration or repair by others in such manner as in Star's judgment affects the product materially and adversely shall void this warranty.

THE FOREGOING WARRANTIES ARE EXCLUSIVE AND ARE IN LIEU OF ALL OTHER WARRANTIES (WHETHER WRITTEN, ORAL OR IMPLIED) INCLUDING WARRANTIES OF MERCHANTABILITY AND WARRANTY OF FITNESS FOR A PARTICULAR PURPOSE.

STAR INDUSTRIES LIMITED WARRANTY

Star Products are warranted to the original purchaser against defective workmanship and/or materials (when properly installed, used, and maintained) for a period as specified below from date of delivery to the customer by an authorized Star Dealer or direct from Star Industries. This warranty does not cover misuse, abuse, normal wear and tear, or accidental damage.

5 year Warranty: All Star products except as noted below. (Includes HD Auger Drives & most non-hydraulic products)

2 year Warranty: Medium Duty Auger Drives

1 year Warranty: Auger Bits and Auger Accessories (excludes auger drives), Crane Forks, Grapples, Angle Broom, Self Dumping Hoppers, Replacement Forks, and Over the Bucket Forks

6 month Warranty: Concrete Mixers

WARRANTY CLAIM NOTIFICATION:

Product defects should be reported to the Star dealer from whom the product was purchased or to Star Industries in writing promptly after discovery. Preferably photographs showing the defect should also be provided along with a written report of circumstances involved. Warranty claims not made within 30 days after discovery of the defect shall be null and void.

WARRANTY DETERMINATION:

If a warranty claim is found worthy and made within the warranty period we reserve the right at our discretion to repair existing defects or to replace it with the same or current model free of charge or to issue a credit for the reasonable cost of repair or take possession of the equipment and issue reimbursement for the calculated value.

Installation:

On the forks installation: Insert the forks into the fork pockets and then slide the spreader bar all the way onto the forks so the pin plates extend behind the back of the fork. Insert the fork locking pins in each side and secure them with hair-pins to lock the spreader bar to the forks. Then secure the safety chains to a strong part of the forklift carriage making sure the chains are not slack and installed as close to a straight horizontal pull as possible. The chain angle must not exceed 45 degrees vertical.

DANGER - DO NOT USE WITHOUT INSTALLING RETAINING PINS behind the heel of each fork and securing with hair pins or cotter pins

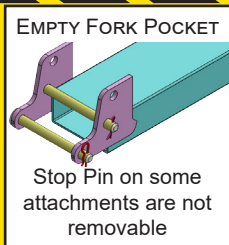
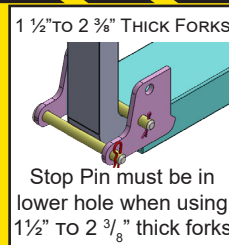
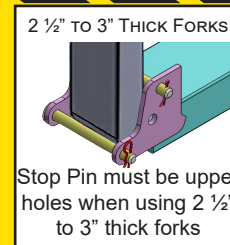
 <p>EMPTY FORK POCKET</p> <p>Stop Pin on some attachments are not removable</p>	 <p>1 1/2" TO 2 3/8" THICK FORKS</p> <p>Stop Pin must be in lower hole when using 1 1/2" TO 2 3/8" thick forks</p>	 <p>2 1/2" TO 3" THICK FORKS</p> <p>Stop Pin must be upper holes when using 2 1/2" to 3" thick forks</p>
--	--	--

Safety chain(s) must also be used. Wrap chain around a strong part of the fork carriage and secure with locking grab hook.

Adjust the width:

Adjust the spreader bar to the desired width by removing the adjustment pins and sliding out the inner section of the spreader bar. The spreader bar can be set for 8, 10, or 12 foot widths. There is a stop to prevent the inner section from being slid all the way out of the center tube however the spreader bar must not be used pulled all the way out to the stops. The inner section must be slid in far enough to align the holes so the width adjustment pins can be installed and secured with a hair-pin. The bar must be extended an equal distance on both sides.

Rated Capacities:

Rated capacities shown below also appear on the spreader bar decal(s). Be aware that these capacities are for the spreader bar itself and do not in any way reflect the capacity of the forklift. Refer to the forklift operator's manual for capacity ratings and any limitations or restrictions when using this type of attachment. Remember the weight of the bar must be deducted from the lift capacity of the forklift. If there is any question as to forklift's lifting capacities when using this attachment, contact the forklift manufacturer for clarification.

Never exceed the rated capacities of the spreader bar except for purpose of a test and then do not exceed 125% of its rated capacity.

Never exceed the capacity of the forklift.

Make sure also that the load rating for slings, chains, or straps used with the spreader are equal to or exceed the rating of both the forklift and the spreader bar, if not; always limit the load to the lowest rated part of the lifting system.

Operation:

1. Before elevating the load make sure the forklift mast or boom is level (vertical) - not leaning to the right or left. Do not use the spreader bar when operating on a side slope.
2. Before the load is raised make sure slings, chains, or straps are properly secured and are not twisted around each other or entangled.
3. The load must be picked up so that it is equally balanced and hangs level.
4. When lifting a load, guard against shock loading by taking up the slack in slings or straps slowly.
5. Prevent jerking at the beginning of the lift, and accelerate or decelerate slowly.
6. Do not use the spreader bar to drag or pull a load.
7. Do not leave suspended loads unattended.
8. Take care that the load does not swing or come in contact with an obstruction.
9. Keep all personnel clear while the load is being raised, moved, or lowered. Forklift/crane operator should watch the load at all times when it is in motion.
10. Never allow more than one person to give signals to the forklift operator except to warn of a hazardous situation.
11. Never raise or carry the load higher than necessary.
12. Never allow anyone to work under a suspended load.

RATED LOAD CAPACITY	
Empty Weight - 545lbs.	
Center Hook used alone	6,000 lbs.
At 8 feet wide	8,000 lbs.
Extended to 10 feet wide	6,400 lbs.
Extended to 12 feet wide	5,000 lbs.

Model 1150C-FP300C

